

AIR

ACCESSOIRES

SUPPORT COULISSANT
DOUBLE SIMPLE

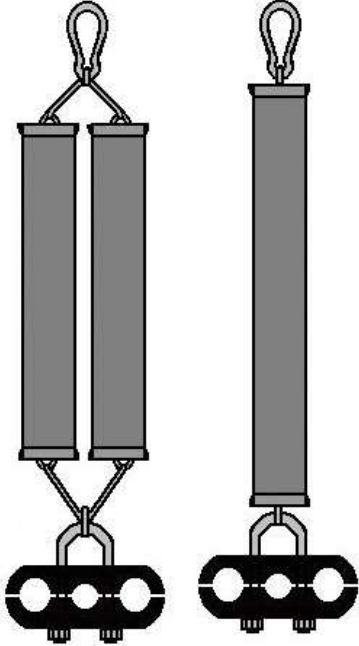

BOYAUX DE CAOUTCHOUC PRÉFABRIQUÉS



418-2-518	18"	418-2-534	34"
418-2-520	20"	418-2-536	36"
418-2-522	22"	418-2-538	38"
418-2-524	24"	418-2-540	40"
418-2-526	26"	418-2-542	42"
418-2-528	28"	418-2-544	44"
418-2-530	30"	418-2-548	48"
418-2-532	32"	418-2-554	54"
418-2-534	34"	418-2-550	50"
418-2-536	36"	418-2-560	60"
		418-2-572	72"

RESSORT DE SOUTIEN POUR BOYAU DE CAOUTCHOUC



ENTRETOISE POUR BOYAU

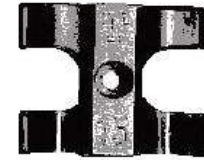

418-1-115 | 3/8"

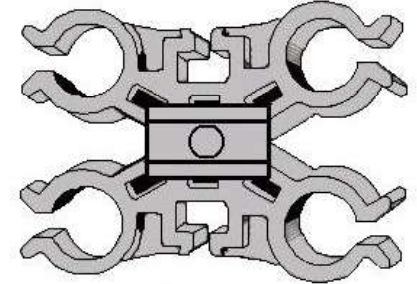

418-1-093 | 3/8-3/8

418-1-094 | 1/2-1/2

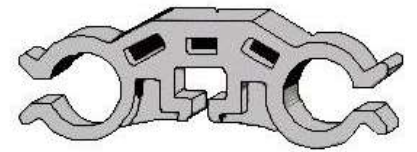

432-1-021 | ressort simple (16")

418-1-051 | 1 1/4" x 25 1/2"

432-1-022 | ressort double (16")

418-1-053 | 1" x 12 1/2"

418-1-096 | 3/8-3/8

432-1-023 | CROCHET

418-1-054 | 1" x 15"

418-1-097 | 1/2-1/2

SUPPORT POUR BOYAU

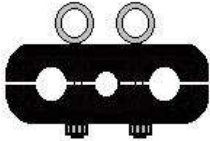

418-1-007HD | DOUBLE

418-1-006 | 1/2'

AGRAFE



418-1-034

MÂT POUR SUPPORT

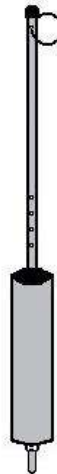

432-1-014-1

RESSORT AVEC CLIP ET ENTRETOISE



418-1-074

SUPPORT MAIN À AIR

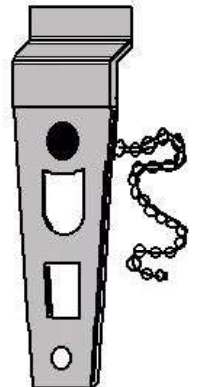

418-11-031

BOYAU CAOUTCHOUC

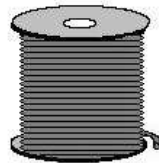

418-1-009 | 3/8"

431-1-068 | 3/8"

418-1-010HD

431-1-071 | 1/2"

ENSEMBLE DE MONTAGE

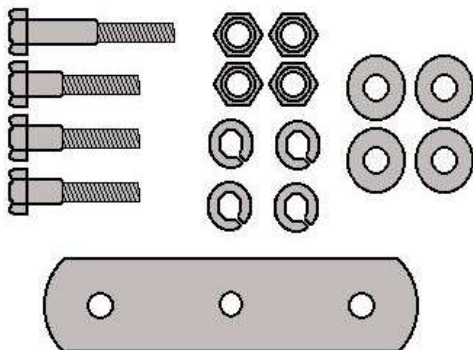

418-11-999

SUPPORT DE BOYAU EN PLASTIQUE

1 FICHE

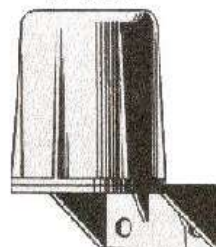

418-11-030

2 FICHES



418-11-019

1 FICHE



418-11-020

RACCORDS POUR TUBE CAOUTCHOUC

ENSEMBLE DE RACCORD

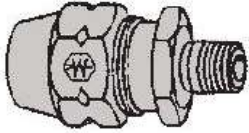
	NO. PIÈCE	DIAM. INT. DU TUBE	FILETAGE
	418-1-036	3/8"	1/4"
	418-1-038		3/8"
	418-1-040		1/2"
	418-1-032	1/2"	1/2"
418-1-031	1/2"	3/8"	

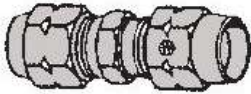

	NO. PIÈCE	DIAM. INT. DU TUBE	FILETAGE
	418-1-033	1/2"	1/2"
	418-1-042	3/8"	3/8"

	NO. PIÈCE	DIAM. INT. DU TUBE	FILETAGE
	418-1-027	1/2"	3/8"
	418-1-028		1/2"
	418-1-037	3/8"	1/4"
	418-1-039		3/8"
	418-1-041		1/2"

NO. PIÈCE	DIAM. INT. DU TUBE	FILETAGE	
TR-31402	3/8"	3/8"	Bague plastique
TR-31403	3/8"	1/2"	Bague plastique
418-1-076	1/2"	3/8"	Bague métal
418-1-075	3/8"	3/8"	Bague métal
418-1-077	3/8"	1/2"	Bague métal

	NO. PIÈCE	DIAM. INT. DU TUBE	FILETAGE
	TR-31408	3/8"	3/8"
	TR-31409	RESSORT	

ÉCROU

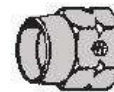

418-1-024	3/8"
418-1-025	1/2"

DOUILLE



418-1-029	1/2"
418-1-030	3/8"

RACCORDS DE TABLIER



NO. PIÈCE	FILETAGE	LONGUEUR
418-1-047	1/4" x 1/2"	1 11/16"
418-1-048	1/4" x 1/2"	2 1/8"

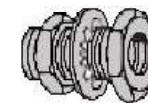

NO. PIÈCE	FILETAGE	LONGUEUR
418-1-021	1/4"	31/32"
418-1-044		1 3/8"
418-1-046		1 1/2"
418-1-045	3/8"	1 1/2"



NO. PIÈCE	FILETAGE	LONGUEUR
418-1-043	1/2" x 1/4"	2 7/8"

RACCORDS POUR TUBE NYLON

TUBE NYLON

RACCORD DE JONCTION

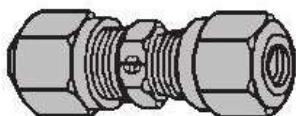

NO. PIÈCE	DIAM. EXTÉRIEUR DU TUBE
WT-1462 X 4	1/4"
WT-1462 X 6	3/8"
WT-1462 X 8	1/2"
WT-1462 X 10	5/8"
WT-1462 X 12	3/4"

NO. PIÈCE	DIAM. EXTÉRIEUR DU TUBE	COLORIS
431-1-057	3/8"	ROUGE
431-1-069	1/2"	
431-1-058	1/4"	NOIR
431-1-070	3/8"	
431-1-067	1/2"	

RACCORD EN T

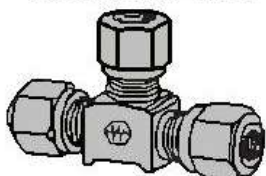

NO. PIÈCE	DIAM. EXTÉRIEUR DU TUBE
WT-1464 X 4	1/4"
WT-1464 X 6	3/8"
WT-1464 X 6 X 4	réducteur 3/8"x3/8"x1/4"
WT-1464 X 8	1/2"

BAGUES



WT-1460 X4	1/4"
WT-1460 X6	3/8"
WT-1460 X8	1/2"
WT-1460 X10	5/8"
WT-1460 X12	3/4"

RACCORD MÂLE



NO. PIÈCE	DIAM. EXTÉRIEUR DU TUBE	FILETAGE
WT-1468 X4	1/4"	1/8"
WT-1468 X4X4		1/4"
WT-1468 X4X6		3/8"
WT-1468 X6	3/8"	1/4"
WT-1468 X6X2		1/8"
WT-1468 X6X6		3/8"
WT-1468 X8	1/2"	3/8"
WT-1468 X8X4		1/4"
WT-1468 X8X8		1/2"
WT-1468 X 10X6	5/8"	3/8"
WT-1468 X 10X12		3/4"
WT-1468 X 12X12	3/4"	3/4"

OEILLETS



WT-1484 X4	1/4"
WT-1484 X5	5/16"
WT-1484 X6	3/8"
WT-1484 X8	1/2"
WT-1484 X10	5/8"
WT-1484 X12	3/4"

COUDE MÂLE

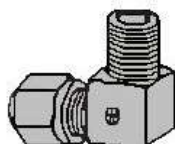

WT-1469 X4	1/4"	1/8"
WT-1469 X4X4		1/4"
WT-1469 X4X6		3/8"
WT-1469 X6X2	3/8"	1/4"
WT-1469 X6X4		1/8"
WT-1469 X6X6		3/8"
WT-1469 X8	1/2"	3/8"
WT-1469 X8X4		1/4"
WT-1469 X8X8		1/2"
WT-1469 X10	5/8"	1/2"
WT-1469 X10X12		3/4"

ÉCROUS



WT-1461 X4	1/4"
WT-1461 X6	3/8"
WT-1461 X8	1/2"
WT-1461 X10	5/8"
WT-1461 X12	3/4"

RACCORD EN T MÂLE

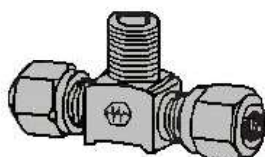

NO. PIÈCE	DIAM. EXTÉRIEUR DU TUBE	FILETAGE
WT-1472 X4	1/4"	1/8"
WT-1472 X6	3/8"	1/4"
WT-1472 X6X6	3/8"	3/8"
WT-1472 X8	1/2"	3/8"